

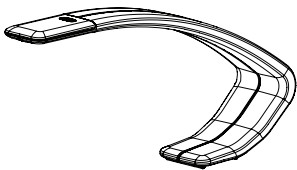
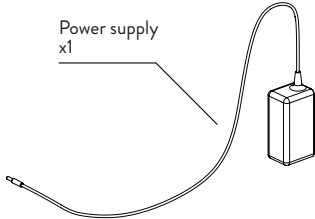
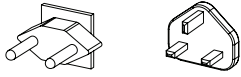

BY  
L/GHTCORP

# Operating Instructions for Amble Task Light

**AMB/001/001**

PARTS INCLUDED:		AMB/001/001	
	Amble Light x1		Power supply x1
			

1A

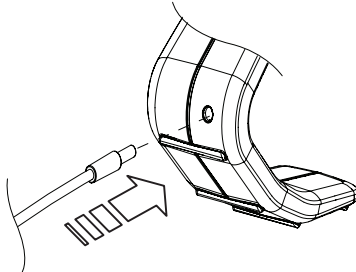

1B

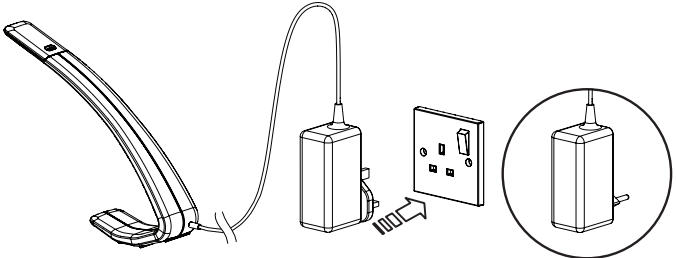

2A

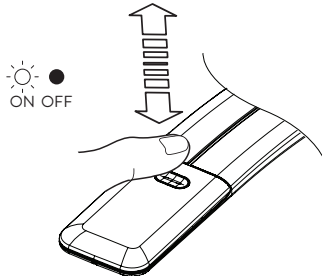

2B

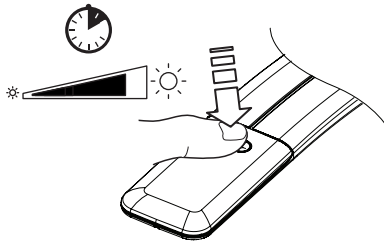

2C

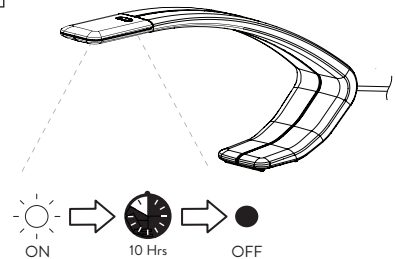

3A

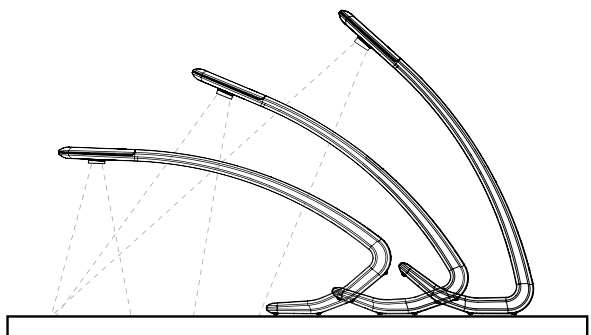
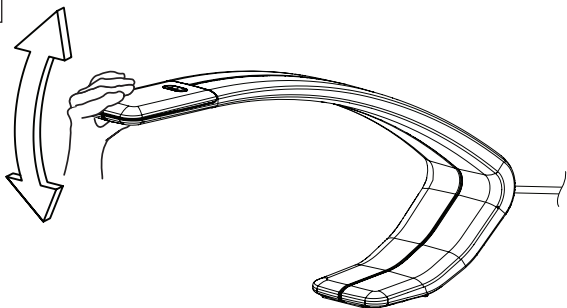



Utiliser en intérieur uniquement  
(Température ambiante: 0 - 40 °C)

Nur für den Innenbereich geeignet  
(Umgebungstemperatur ta: 0 - 40 °C)



Solo para uso en interiores  
(Temperatura ambiente: 0 - 40 °C)

Endast för inomhusbruk  
(Tål temperaturer på högst 40°C)

Indoor use only  
(Ambient temp ta: 0 - 40 °C)

Alleen voor gebruik binnenshuis  
(Omgevingstemperatuur: 0 - 40 °C)



Ne pas nettoyer avec un produit  
d'entretien domestique ou un solvant.  
Toujours débrancher la prise avant le  
nettoyage.

Nicht mit Lösungsmitteln oder anderen  
Haushaltsreinigern putzen. Gerät  
vollständig austecken vor der Reinigung.



No lo limpie con disolventes ni con  
otros productos de limpieza domésticos.  
Desenchufe el cable antes de limpiarlo.

Vid rengöring: Dra alltid ur strömkabeln.  
Använd inte lösningsmedel eller andra  
rengöringsmedel.

Do not clean with solvents or other  
household cleaners. Always unplug  
the power cable when cleaning.

Niet reinigen met oplosmiddelen of  
andere reinigingsmiddelen. Haal tijdens  
het schoonmaken altijd de stekker eruit.



Ne pas utiliser dans des conditions  
humides. Ne pas immerger dans un  
liquide.

Gerät nicht ins Wasser tauchen und  
vor Nässe schützen.

No utilice el dispositivo en lugares  
húmedos ni lo introduzca en agua.

Använd inte i våtutrymmen eller i  
närheten av vatten.

Do not use in wet conditions  
Or immerse in water.

Niet gebruiken in natte  
omstandigheden/niet in water  
onderdompelen.

En cas d'avarie, ce produit ne peut pas  
être réparé. Si le cordon souple est  
endommagé ou si le boîtier est fissuré,  
le produit ne doit plus être utilisé.

Das Produkt kann nicht repariert  
werden, wenn das Gehäuse oder das  
Kabel beschädigt sind. In diesem Fall  
das Gerät Fachgerecht entsorgen.

El producto no puede repararse  
si se estropea. Si el cable flexible  
está dañado o la carcasa se agrieta,  
deseche correctamente el dispositivo.

Produkten kan inte repareras om den  
skadas. Om den flexibla kabeln skadas  
eller om lådan skadas eller spricker,  
kassera på lämpligt sätt.

The product cannot be repaired if it  
is damaged. If the flexible cable is  
damaged or the case is cracked or  
damaged dispose of appropriately.

Een beschadigd product kan niet worden  
gerepareerd. Als het flexibele snoer  
beschadigd is of wanneer de behuizing  
gebarsten of beschadigd is, verwijder  
het dan op gepaste wijze.

Ne pas couvrir pendant l'utilisation.

Nicht abdecken, wenn im Einsatz.

No cubra el dispositivo si lo está  
utilizando.

Får ej övertäckas vid användning.

Do not cover when in use.

Niet afdekken tijdens gebruik.

Dérouler le cordon sur toute sa  
longueur avant d'utiliser le produit.

Kabel vor Verwendung vollständig  
ausrollen.

Desenrolle totalmente el cable antes  
de usarlo.

Dra ur sladden helt före användning.

Unwind cable fully before use.

Rol het snoer vóór gebruik helemaal  
af.



The light source of this luminaire is not replaceable; when the light source reaches its end of life the whole luminaire shall be replaced.



#### DISCLAIMER

As part of our ongoing product improvement programme, the design of products may change without prior notice and details may vary from those illustrated.